

Ansicht "A"

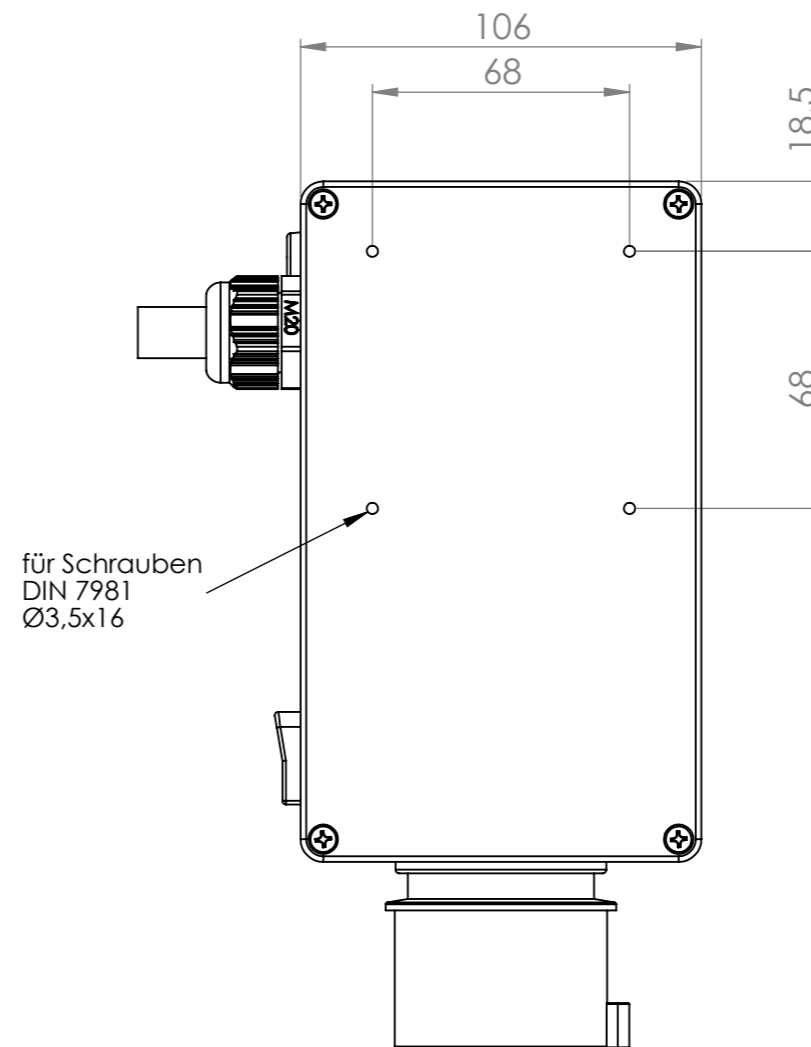

				Tag	Name	Bezeichnung 0098.3910
			Bearb.	25.10.2013	Krämer	
			Gepr.			ZgNr. G:\SW\Ma\Ku\Intern\00983910\
Ind. Änderung		Tag	Name	KLINGER BORN		