

Ansicht "A"

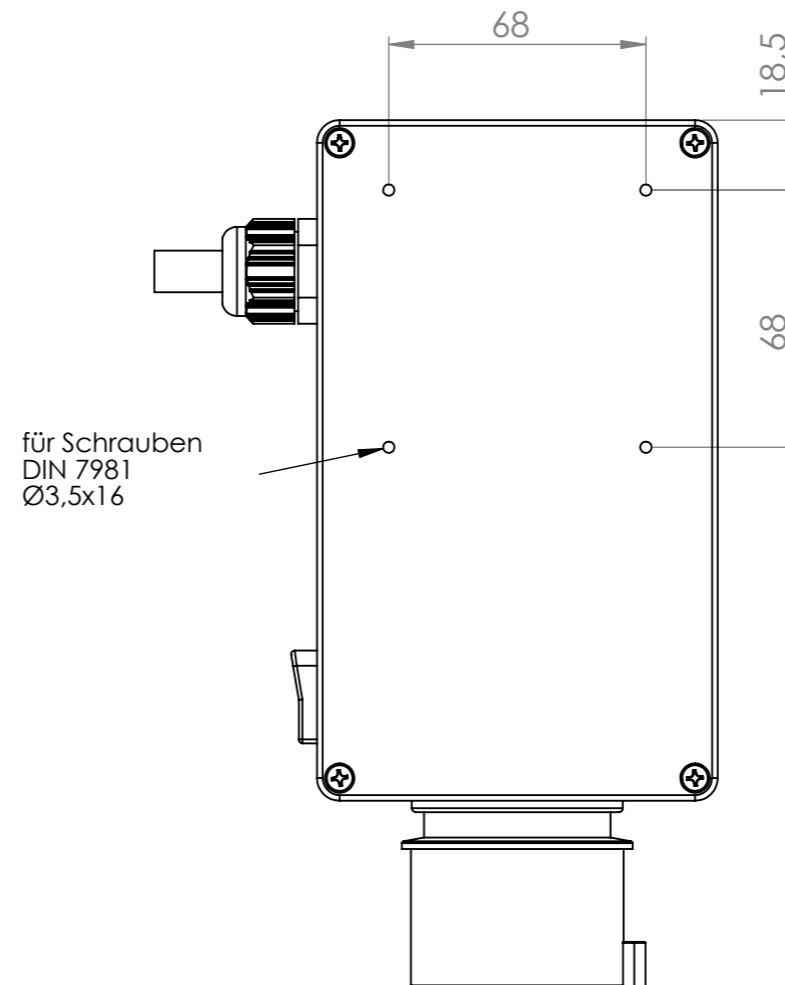

				Tag	Name	Bezeichnung 0098.3960
				Bearb. 30.10.2013	Krämer	
				Gepr.		ZgNr. G:\SW\Ma\Ku\Intern\00983960\
Ind. Änderung		Tag	Name	<b>KLINGER BORN</b>		