

# Overall dimensions

F202

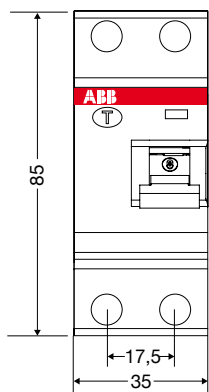

F204

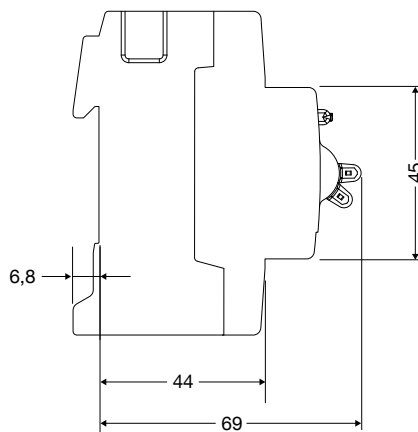
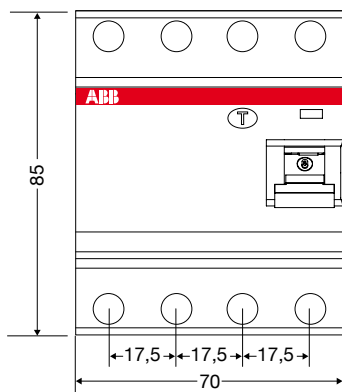

DS201

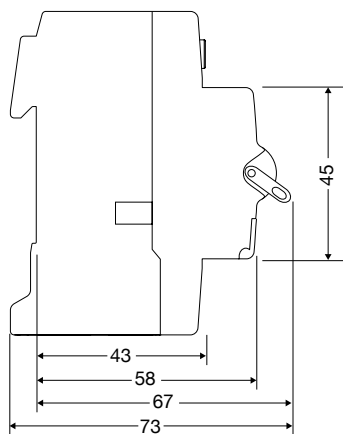
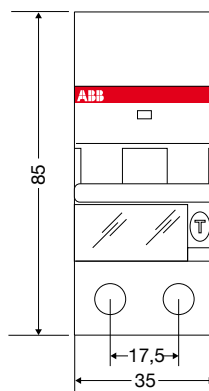

DDA 202

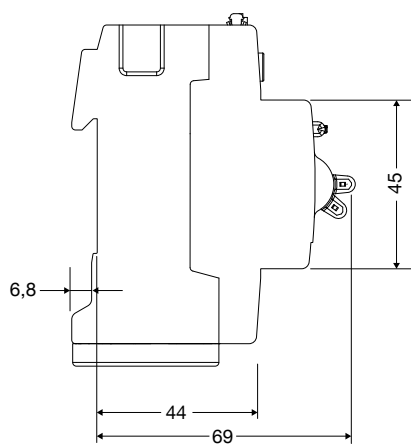
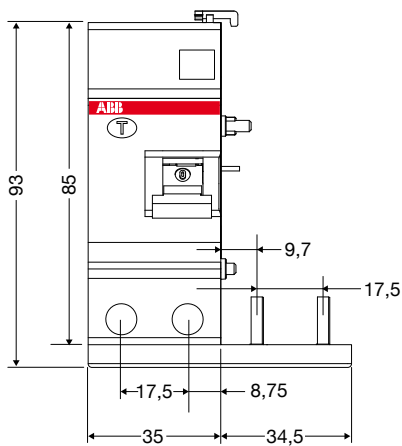

Dimensions in mm