

EF19, EF45 electronic overload relays

0.10 to 45.0 A



1SBC101147F0010

EF19-18.9



1SBC101148F0010

EF45-30

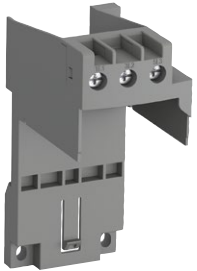

2CDC31024V0013

DB19EF



2CDC231022V0014

DB45EF



1SFC151224F0002

KPR-101L

Description

The EF19 and EF45 are self-supplied electronic overload relays, which means no extra external supply is needed. It offers reliable protection for motors in the event of overload or phase failure. Easy to use like a thermal overload relay and compatible with standard motor applications, the electronic overload relay is convincing, above all, due to its wide setting range, high accuracy, high operational temperature range and the possibility to select a trip class (10E, 20E, 30E). Further features are the temperature compensation, trip contact (N.C.), signal contact (N.O.), automatic or manual reset selectable, trip-free mechanism, STOP and TEST function and a trip indication. The overload relays are connected directly to the contactors.

Ordering details

Setting range	Short-circuit protective device	Trip class	Type	Order code	Weight (1 pc) kg
A					
EF19 electronic overload relays					
0.10 ... 0.32	1 A, fuse type gG	10E, 20E, 30E	EF19-0.32	1SAX121001R1101	0.158
0.30 ... 1.00	4 A, fuse type gG	10E, 20E, 30E	EF19-1.0	1SAX121001R1102	0.158
0.80 ... 2.70	10 A, fuse type gG	10E, 20E, 30E	EF19-2.7	1SAX121001R1103	0.158
1.90 ... 6.30	20 A, fuse type gG	10E, 20E, 30E	EF19-6.3	1SAX121001R1104	0.158
5.70 ... 18.9	50 A, fuse type gG	10E, 20E, 30E	EF19-18.9	1SAX121001R1105	0.158
EF45 electronic overload relays					
9.00 ... 30.0	160 A, fuse type gG	10E, 20E, 30E	EF45-30	1SAX221001R1101	0.362
15.0 ... 45.0	160 A, fuse type gG	10E, 20E, 30E	EF45-45	1SAX221001R1102	0.362

Ordering details accessories

Suitable for	Description	Type	Order code	Weight (1 pc) kg
EF19	Single mounting kit	DB19EF	1SAX101910R1001	0.046
EF45	Single mounting kit	DB45EF	1SAX201910R0001	0.100
EF19, EF45	Reset push button*	KPR-101L	1SFA616162R1014	0.019

*Note: for more information see catalogue 1SFC151004C0201

Main dimensions mm, inches

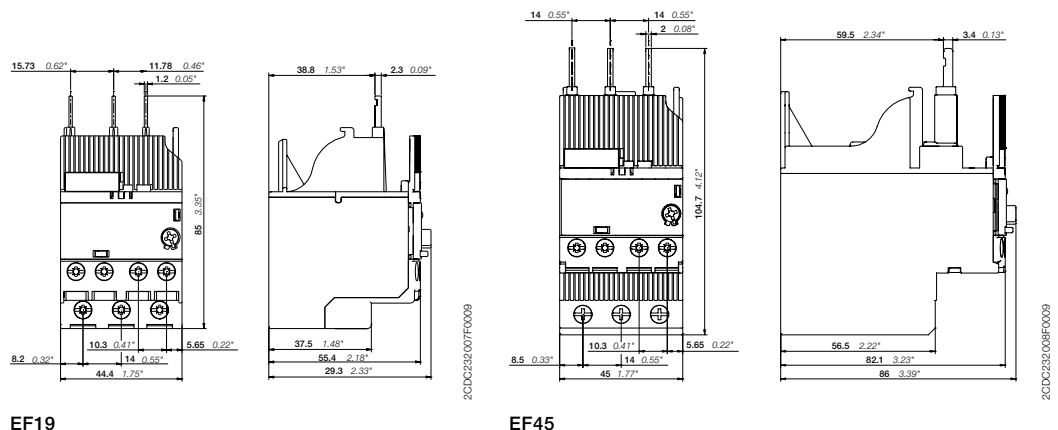

E16DU, EF19, EF45 electronic overload relays

Technical data

Main circuit – Utilization characteristics according to IEC/EN

Type	E16DU	EF19	EF45
Standards	IEC/EN 60947-1, IEC/EN 60947-4-1, IEC/EN 60947-5-1		
Rated operational voltage U_n	690 V AC		
Rated frequency	50/60 Hz – not suitable for DC applications		
Trip class	10E, 20E, 30E, selectable		
Number of poles	3		
Duty time	100 %		
Operating frequency without early tripping	Up to 15 operations/h, see "Technical diagram – Intermittent periodic duty"		
Rated impulse withstand voltage U_{imp}	6 kV		
Rated insulation voltage U_i	690 V AC		

Auxiliary circuit according to IEC/EN

Type	E16DU	EF19	EF45
Rated operational voltage U_n	600 V AC / DC		
Conventional free air thermal current I_n	6 A		
Rated frequency	DC, 50/60 Hz		
Number of poles	1 N.C. + 1 N.O.		
I_n / Rated operational current AC-15 acc. to IEC/EN 60947-5-1 for utilization category			
110-120 V	50/60 Hz	3.00 A	
220-230-240 V	50/60 Hz	3.00 A	
440 V	50/60 Hz	1.10 A	
480-500 V	50/60 Hz	0.75 A	
I_n / Rated operational current DC-13 acc. to IEC/EN 60947-5-1 for utilization category			
24 V		1.50 A	
60 V		0.55 A	
110-120-125 V		0.55 A	
250 V		0.27 A	
Minimum switching capacity	12 V / 3 mA		
Short-circuit protective devices	6 A, fuse type gG		
Rated impulse withstand voltage U_{imp}	6 kV		
Rated insulation voltage U_i	690 V		

Technical diagram – Intermittent periodic duty

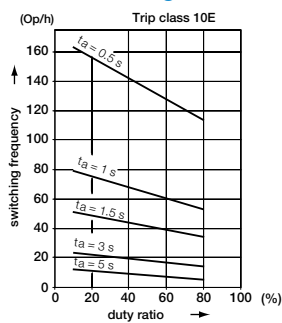

Trip class 10E

2CDDC230001F0214

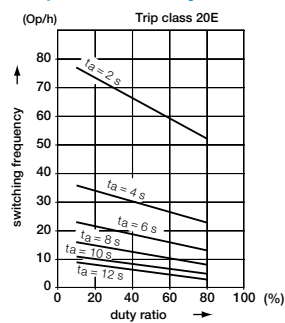

Trip class 20E

2CDDC230002F0214

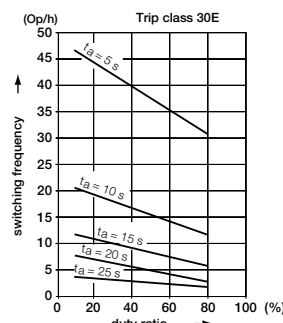

Trip class 30E

2CDDC230003F0214

E16DU, EF19, EF45 electronic overload relays

Technical data

Main circuit – Utilization characteristics according to UL/CSA

Type	E16DU	EF19	EF45
Standards	UL 508, CSA 22.2 No. 14		
Maximum operational voltage	600 V AC		
Trip rating	125 % of FLA		
Full load amps (FLA)	See table "Full load amps and short-circuit protective device"		
Short-circuit rating RMS symmetrical	See table "Full load amps and short-circuit protective device"		
Short-circuit protective device	See table "Full load amps and short-circuit protective device"		

Auxiliary circuit according to UL/CSA

Type	E16DU	EF19	EF45
Contact rating	N.C., 95-96	B600, Q300	B600, Q600
	N.O., 97-98	B600, Q300	B600, Q600
Conventional free-air thermal current	6 A		

Full load amps and short-circuit protective device

Type	Full load amps (FLA)	Short-circuit protective device					
		480 V AC		600 V AC		SCCR	Fuse type
		SCCR	Fuse type	SCCR	Fuse type		
E16DU-0.32	0.32 A	50 kA	2 A, Class J	5 kA	2 A, K5 / RK5	100 kA	2 A, Class J
E16DU-1.0	1.00 A	50 kA	2 A, K5 / RK5	5 kA	2 A, K5 / RK5	100 kA	2 A, Class J
E16DU-2.7	2.70 A	50 kA	4 A, K5 / RK5	5 kA	4 A, K5 / RK5	100 kA	4 A, Class J
E16DU-6.3	6.30 A	50 kA	15 A, K5 / RK5	5 kA	15 A, K5 / RK5	100 kA	15 A, Class J
E16DU-18.9	18.90 A	50 kA	30 A, K5 / RK5	5 kA	30 A, K5 / RK5	100 kA	30 A, Class J

Type	Full load amps (FLA)	Short-circuit protective device					
		480 V AC		600 V AC		SCCR	Fuse type
		SCCR	Fuse type	SCCR	Fuse type		
EF19-0.32	0.32 A	50 kA	2 A, Class J	5 kA	2 A, K5 / RK5	100 kA	2 A, Class J
EF19-1.0	1.00 A	50 kA	2 A, K5 / RK5	5 kA	2 A, K5 / RK5	100 kA	2 A, Class J
EF19-2.7	2.70 A	50 kA	4 A, K5 / RK5	5 kA	4 A, K5 / RK5	100 kA	4 A, Class J
EF19-6.3	6.30 A	50 kA	15 A, K5 / RK5	5 kA	15 A, K5 / RK5	100 kA	15 A, Class J
EF19-18.9	18.90 A	50 kA	30 A, K5 / RK5	5 kA	30 A, K5 / RK5	100 kA	30 A, Class J

Type	Full load amps (FLA)	Short-circuit protective device					
		480 V AC		600 V AC		SCCR	Fuse type
		SCCR	Fuse type	SCCR	Fuse type		
EF45-30	30 kA	18 kA	150 A, K5 / RK5	18 kA	150 A, K5 / RK5	100 kA	150 A, Class J
EF45-45	45 kA	18 kA	200 A, K5 / RK5	18 kA	200 A, K5 / RK5	100 kA	200 A, Class J

E16DU, EF19, EF45 electronic overload relays



Technical data

General data





Type	E16DU	EF19	EF45
Pollution degree	3		
Phase loss sensitive	Yes		
Ambient air temperature			
Operation	Open - compensated		
Storage	-25 ... +70 °C		
Ambient air temperature compensation	-50 ... +85 °C		
Ambient air temperature compensation	Acc. to IEC/EN60947-4-1		
Maximum operating altitude permissible	2000 m		
Resistance to shock acc. to IEC 60068-2-27	15g / 11 ms pulse	25g / 11 ms pulse	
Resistance to vibrations acc. to IEC 60068-2-6	5g / 3 ... 150 Hz	3g / 3 ... 150 Hz	
Mounting position	Position 1-6		
Mounting	Mount on the contactor and tighten the screws of the main circuit terminals		
Degree of protection	Housing	IP20	
	Main circuit terminals	IP20	

Electrical connection

Main circuit

Type	E16DU	EF19	EF45
Connecting capacity			
 Rigid	1 or 2 x 1 ... 4 mm ²	1 4 mm ²	2.5 ... 16 mm ²
 Flexible with insulated ferrule	1 or 2 x 0.75 ... 2.5 mm ²	0.75 ... 2.5 mm ²	2.5 ... 10 mm ²
Stranded acc. to UL/CSA	1 or 2 x AWG 16-10	AWG 16-10	
Flexible acc. to UL/CSA	1 or 2 x AWG 16-10	AWG 16-10	
Stripping length	9 mm	9 mm	13 mm
Tightening torque	0.8 ... 1.5 Nm / 7 ... 13 lb.in	0.8 ... 1.5 Nm / 7 ... 13 lb.in	2.3 ... 2.6 Nm / 20 ... 22 lb.in
Recommended screw driver	M3.5 (Pozi driv 2)	M3.5 (Pozi driv 2)	M3.5 (Pozi driv 2)

Auxiliary circuit

Type	E16DU	EF19	EF45
Connecting capacity			
 Rigid	1 or 2 x 1 ... 4 mm ²	1 ... 4 mm ²	1 ... 4 mm ²
 Flexible with ferrule	1 or 2 x 0.75 ... 2.5 mm ²	0.75 ... 2.5 mm ²	0.75 ... 2.5 mm ²
 Flexible with insulated ferrule	1 or 2 x 0.75 ... 2.5 mm ²	0.75 ... 2.5 mm ²	0.75 ... 2.5 mm ²
 Flexible	1 or 2 x 0.75 ... 2.5 mm ²	0.75 ... 2.5 mm ²	0.75 ... 2.5 mm ²
Stranded acc. to UL/CSA	1 or 2 x AWG 16-10	AWG 18-10	
Flexible acc. to UL/CSA	1 or 2 x AWG 16-10	AWG 18-10	
Stripping length	9 mm	9 mm	9 mm
Tightening torque	0.8 ... 1.2 Nm / 7 ... 11 lb.in	0.8 ... 1.2 Nm / 7 ... 11 lb.in	0.8 ... 1.2 Nm / 7 ... 11 lb.in
Recommended screw driver	M3 (Pozi driv 2)	M3 (Pozi driv 2)	M3 (Pozi driv 2)